

Sygnalizator świetlny PKP, skala 1:45 (0)

1cm

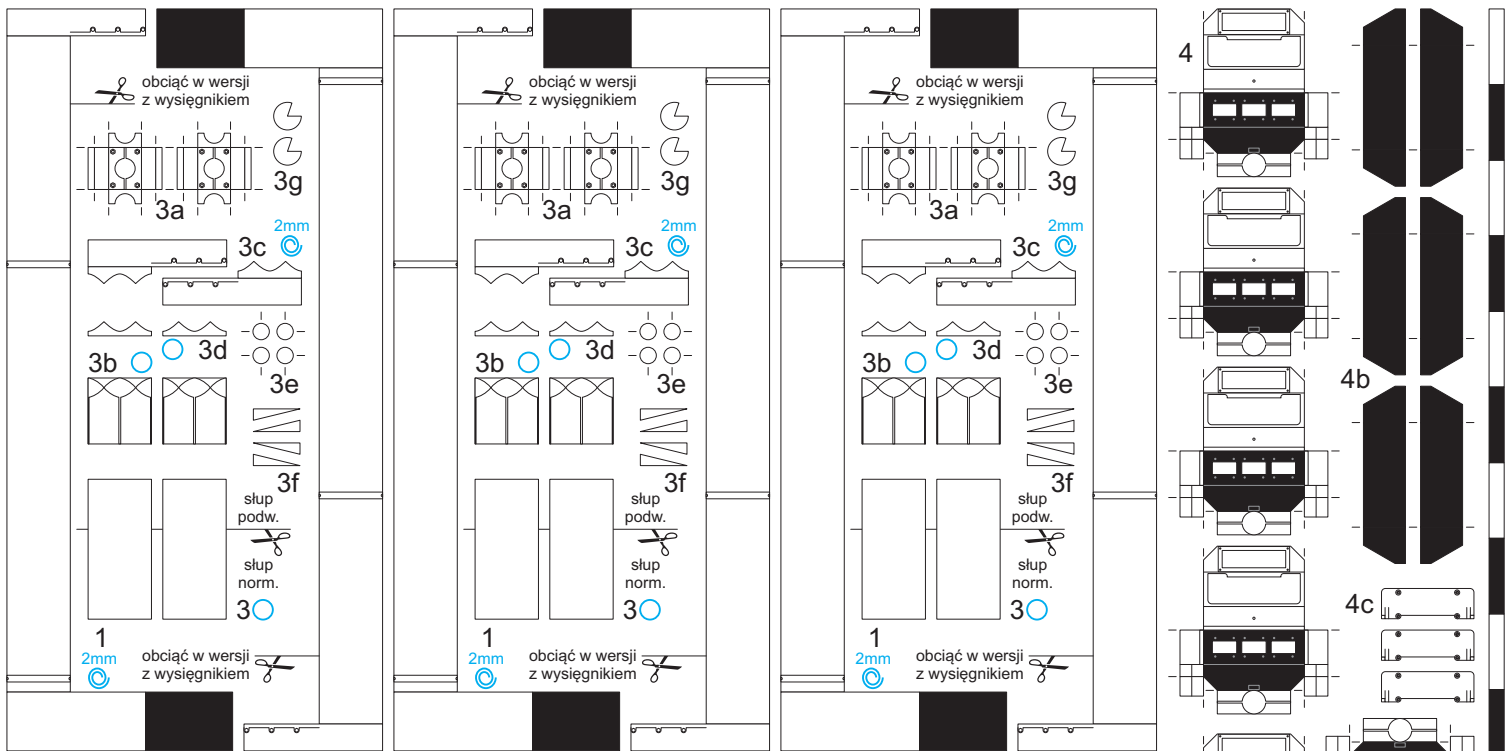

Słupy sygnalizatorów samoczynnych

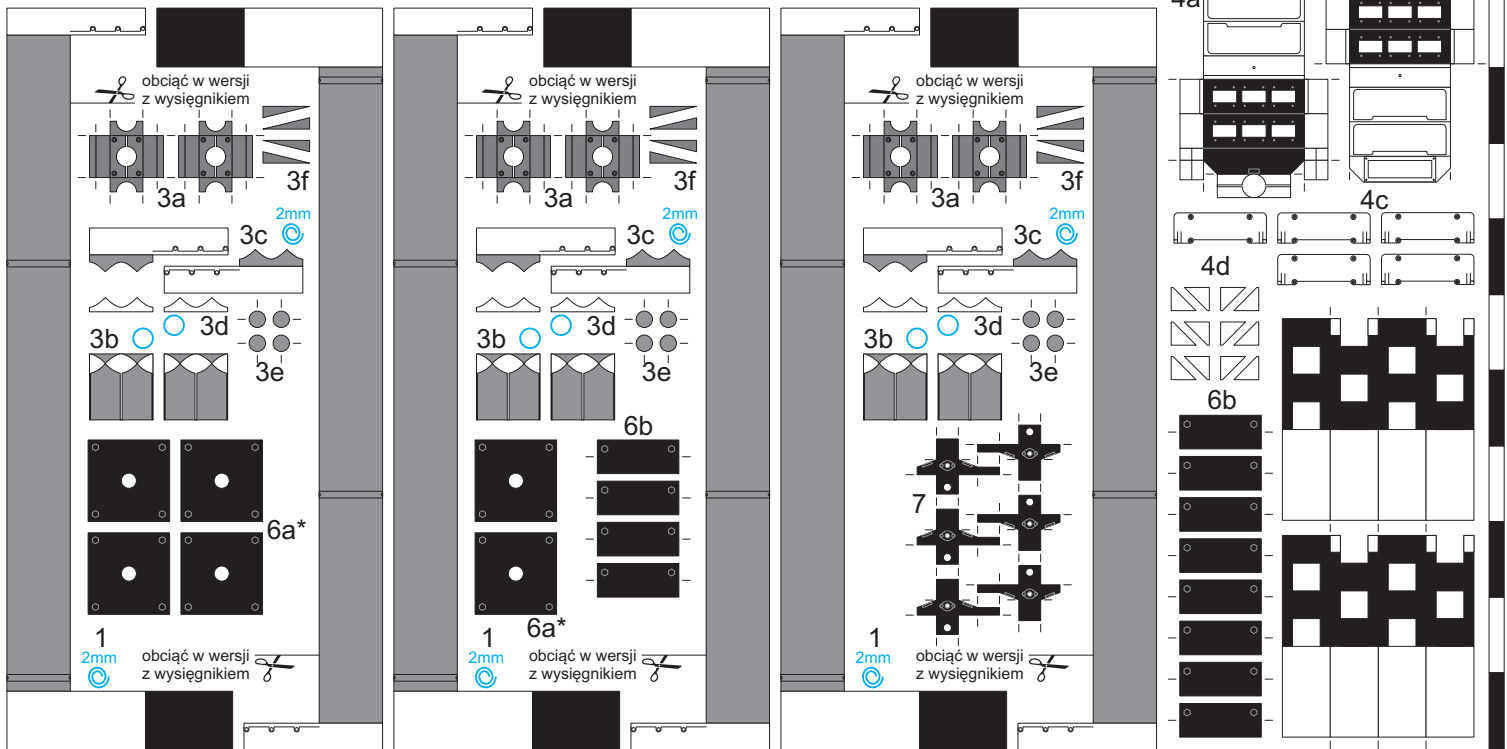

Słupy pozostałych sygnalizatorów

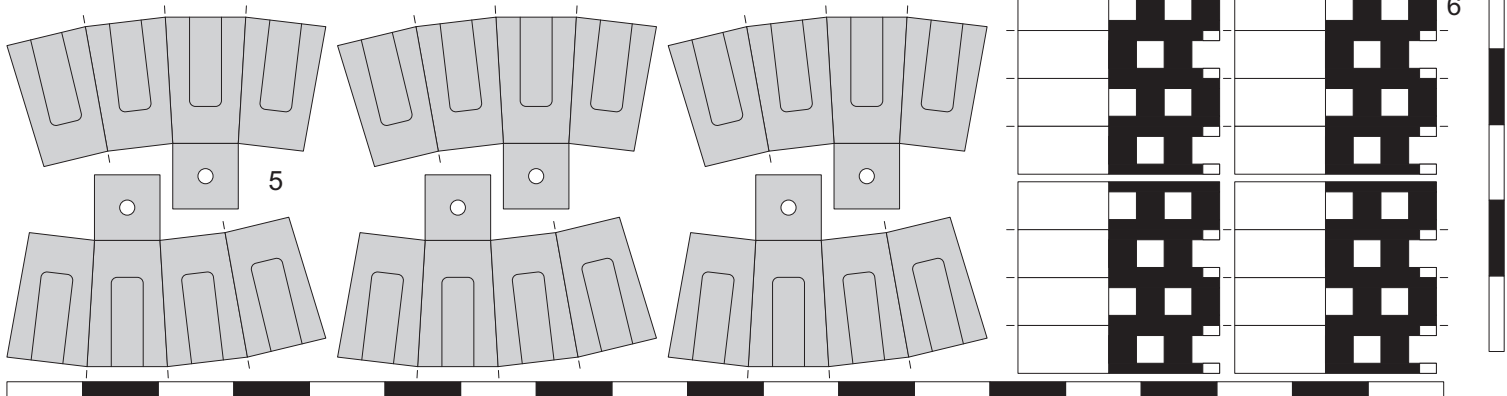

Sygnalizator świetlny PKP, skala 1:45 (0)

A	B	C	D	E	F	G	H	I	J	K	L	M	N	O	P	R	S	T	U	V	W	X	Y	Z					
A ^{1/2}	B ^{1/2}	C ^{1/2}	D ^{1/2}	E ^{1/2}	F ^{1/2}	G ^{1/2}	H ^{1/2}	I ^{1/2}	J ^{1/2}	K ^{1/2}	L ^{1/2}	M ^{1/2}	N ^{1/2}	O ^{1/2}	P ^{1/2}	R ^{1/2}	S ^{1/2}	T ^{1/2}	U ^{1/2}	V ^{1/2}	W ^{1/2}	X ^{1/2}	Y ^{1/2}	Z ^{1/2}					
A ²	B ²	C ²	D ²	E ²	F ²	G ²	H ²	I ²	J ²	K ²	L ²	M ²	N ²	O ²	P ²	R ²	S ²	T ²	U ²	V ²	W ²	X ²	Y ²	Z ²					
ToA	ToB	ToC	ToD	ToE	ToF	ToG	ToH	ToI	ToJ	ToK	ToL	ToM	ToN	ToO	ToP	ToR	ToS	ToT	ToU	ToV	ToW	ToX	ToY	ToZ					
SpA	SpB	SpC	SpD	SpE	SpF	SpG	SpH	SpI	SpJ	SpK	SpL	SpM	SpN	SpO	SpP	SpR	SpS	SpT	SpU	SpV	SpW	SpX	SpY	SpZ					
ISpA	ISpB	ISpC	ISpD	ISpE	ISpF	ISpG	ISpH	ISpI	ISpJ	ISpK	ISpL	ISpM	ISpN	ISpO	ISpP	ISpR	ISpS	ISpT	ISpU	ISpV	ISpW	ISpX	ISpY	ISpZ					
ISpA	ISpB	ISpC	ISpD	ISpE	ISpF	ISpG	ISpH	ISpI	ISpJ	ISpK	ISpL	ISpM	ISpN	ISpO	ISpP	ISpR	ISpS	ISpT	ISpU	ISpV	ISpW	ISpX	ISpY	ISpZ					
ISpA	ISpB	ISpC	ISpD	ISpE	ISpF	ISpG	ISpH	ISpI	ISpJ	ISpK	ISpL	ISpM	ISpN	ISpO	ISpP	ISpR	ISpS	ISpT	ISpU	ISpV	ISpW	ISpX	ISpY	ISpZ					
ISpA	ISpB	ISpC	ISpD	ISpE	ISpF	ISpG	ISpH	ISpI	ISpJ	ISpK	ISpL	ISpM	ISpN	ISpO	ISpP	ISpR	ISpS	ISpT	ISpU	ISpV	ISpW	ISpX	ISpY	ISpZ					
W3A	W3B	W3C	W3D	W3E	W3F	W3G	W3H	W3I	W3J	W3K	W3L	W3M	W3N	W3O	W3P	W3R	W3S	W3T	W3U	W3V	W3W	W3A	W3A	W3Z					
Sz1	Sz2	Sz3	Sz4	Sz5	Sz6	Sz7	Sz8	Sz9	Sz10	Sz11	Sz12	Sz13	Sz14	Sz15	Sz16	Sz17	Sz18	Sz19	Sz20	Sz21	Sz22	Sz23	Sz24	Sz25					
Sz1n	Sz2n	Sz3n	Sz4n	Sz5n	Sz6n	Sz7n	Sz8n	Sz9n	Sz10n	Sz11n	Sz12n	Sz13n	Sz14n	Sz15n	Sz16n	Sz17n	Sz18n	Sz19n	Sz20n	Sz21n	Sz22n	Sz23n	Sz24n	Sz25n					
10	11	12	13	14	15	16	17	18	19	20	21	22	23	24	25	26	27	28	29	30	31	32	33	34	35	36	37	38	39
10N	11N	12N	13N	14N	15N	16N	17N	18N	19N	20N	21N	22N	23N	24N	25N	26N	27N	28N	29N	30N	31N	32N	33N	34N	35N	36N	37N	38N	39N
40	41	42	43	44	45	46	47	48	49	50	51	52	53	54	55	56	57	58	59	60	61	62	63	64	65	66	67	68	69
40N	41N	42N	43N	44N	45N	46N	47N	48N	49N	50N	51N	52N	53N	54N	55N	56N	57N	58N	59N	60N	61N	62N	63N	64N	65N	66N	67N	68N	69N
70	71	72	73	74	75	76	77	78	79	80	81	82	83	84	85	86	87	88	89	90	91	92	93	94	95	96	97	98	99
70N	71N	72N	73N	74N	75N	76N	77N	78N	79N	80N	81N	82N	83N	84N	85N	86N	87N	88N	89N	90N	91N	92N	93N	94N	95N	96N	97N	98N	99N
Tm1	Tm2	Tm3	Tm4	Tm5	Tm6	Tm7	Tm8	Tm9	Tm10	Tm11	Tm12	Tm13	Tm14	Tm15	Tm16	Tm17	Tm18	Tm19	Tm20	Tm21	Tm22	Tm23	Tm24	Tm25	Tm26	Tm27	Tm28	Tm29	Tm30
Tm31	Tm32	Tm33	Tm34	Tm35	Tm36	Tm37	Tm38	Tm39	Tm40	Tm41	Tm42	Tm43	Tm44	Tm45	Tm46	Tm47	Tm48	Tm49	Tm50	Tm51	Tm52	Tm53	Tm54	Tm55	Tm56	Tm57	Tm58	Tm59	Tm60
m	m	m	m	m	m	m	m	m	m	m	m	m	m	m	m	m	m	m	m	m	m	m	m	m	m	m	m	m	m

semafor podający tylko sygnał "wolna droga"
sem. pod. sygnały "wolna droga"/"wolna droga ze zm. pr."
sem. pod. tylko sygnały "wolna droga ze zm. prędkością"
tarcza ostrzegawcza

sygnalizator powtarzający

wskaźnik W3

sygnalizator sygnału zastępczego

sygnalizator SBL

tarcza manewrowa

tabliczki dodatkowe do sygnalizatora z sygnałem jazdy manewrowej

Tabliczki oznaczenia sygnalizatora

Szablony

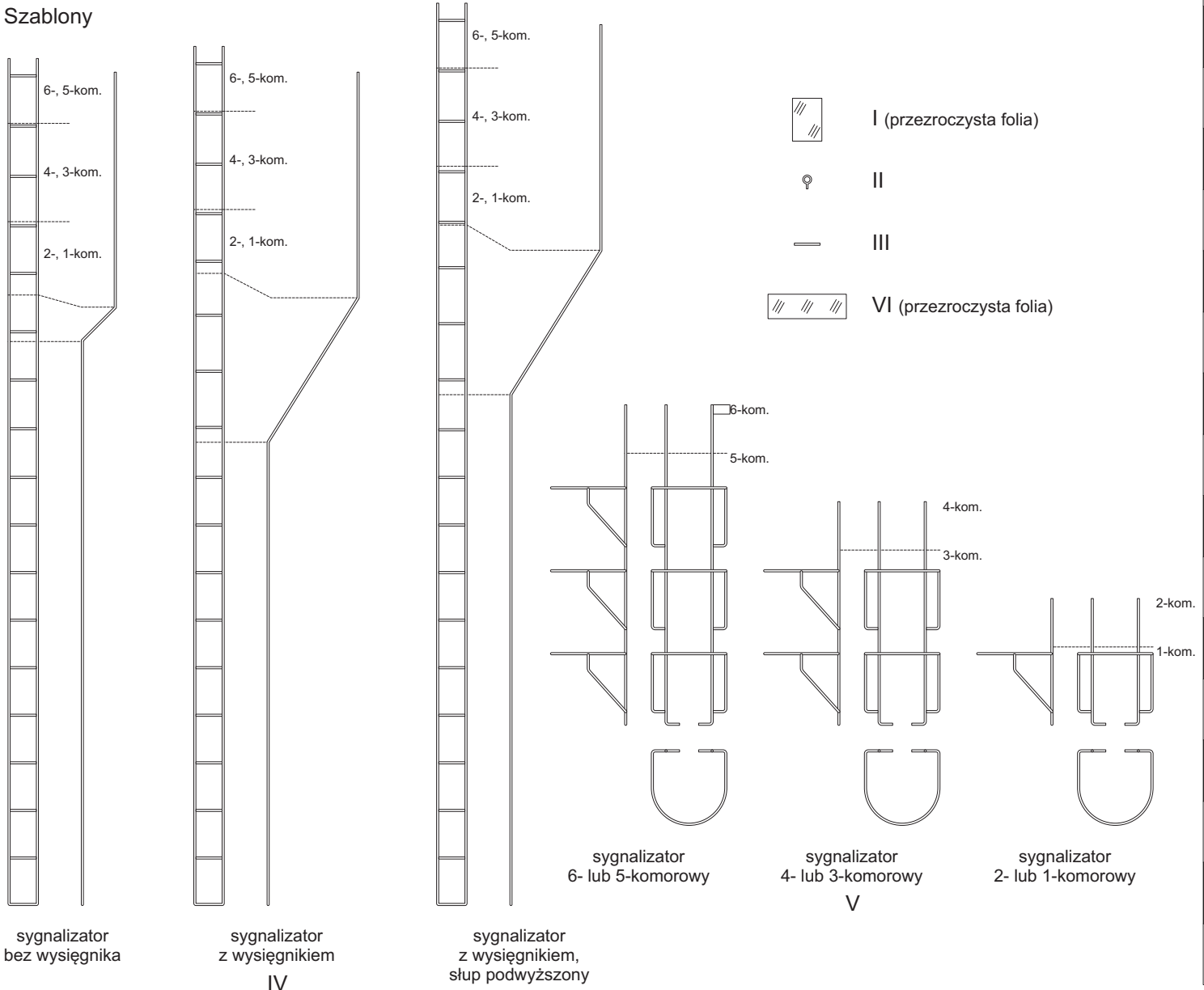

Sygnalizator świetlny PKP, skala 1:45 (0)

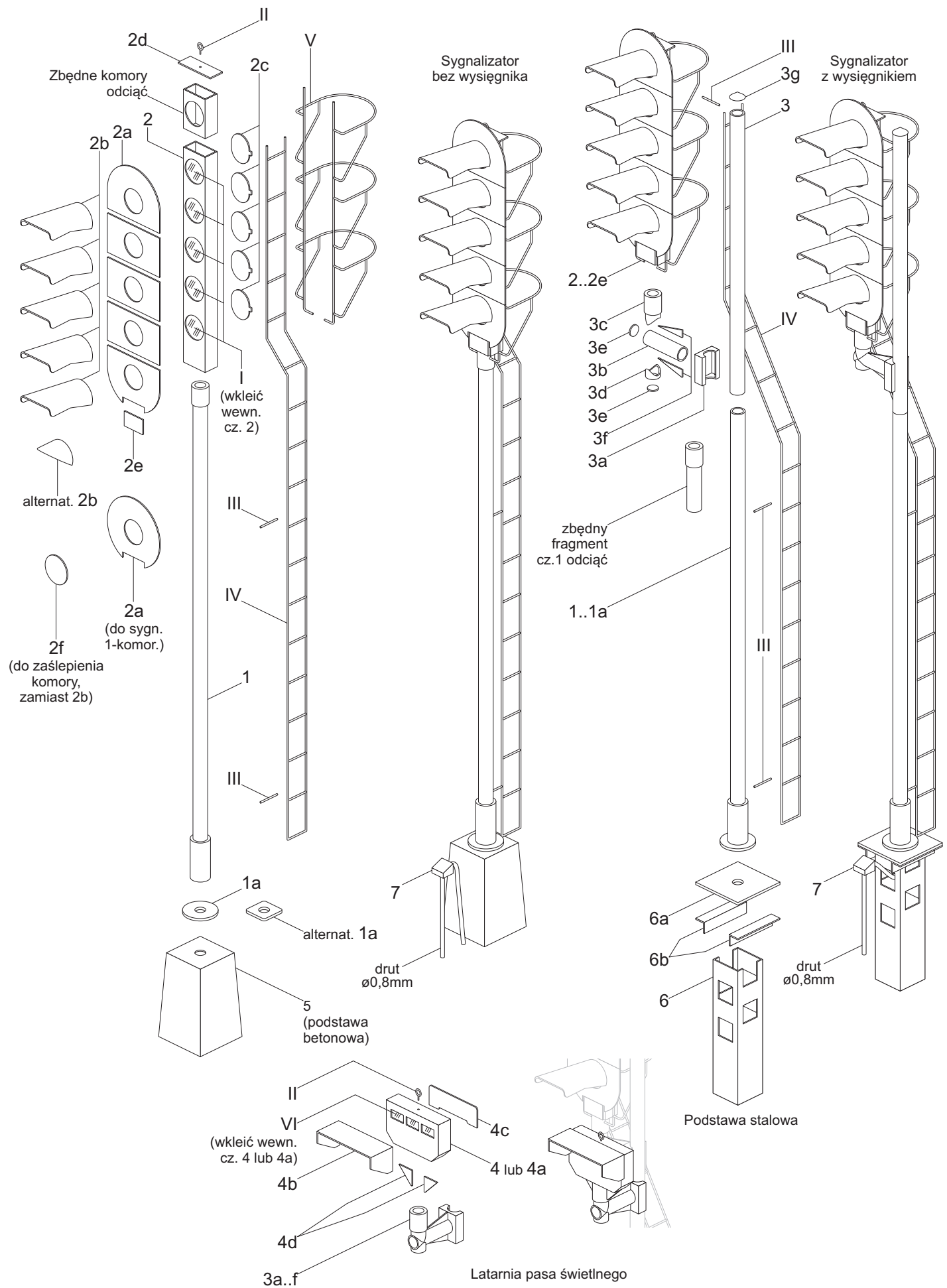

Sygnalizator świetlny PKP, skala 1:45 (0)

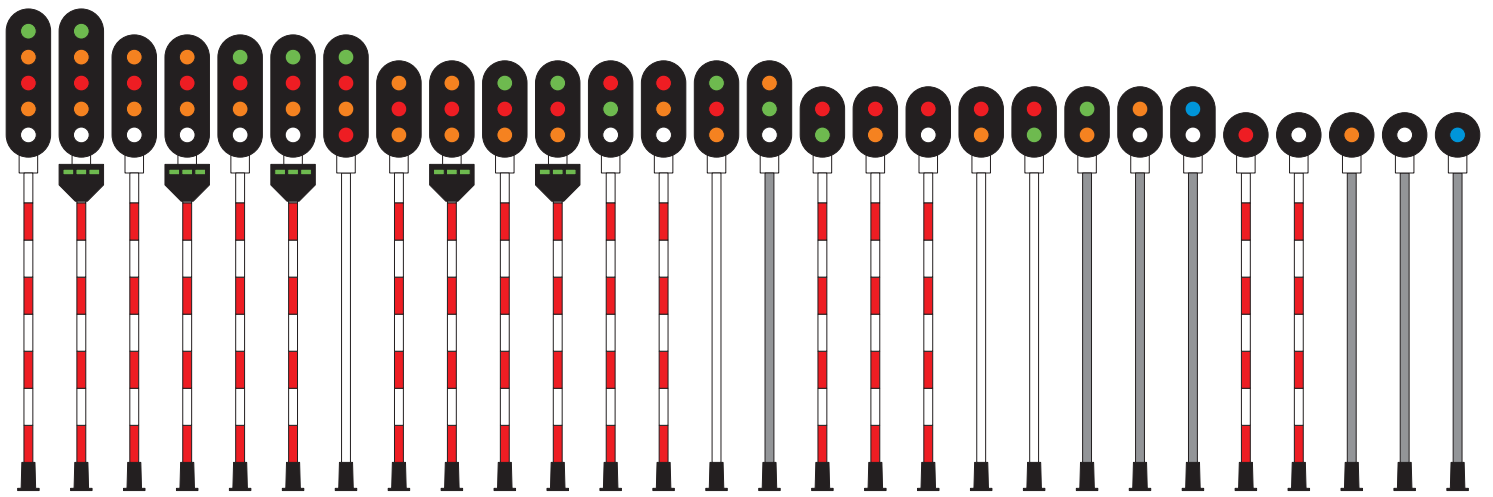

Typowe układy barw komór sygnalizatorów PKP (pas świetlny może być zielony, pomarańczowy lub dwukolorowy).

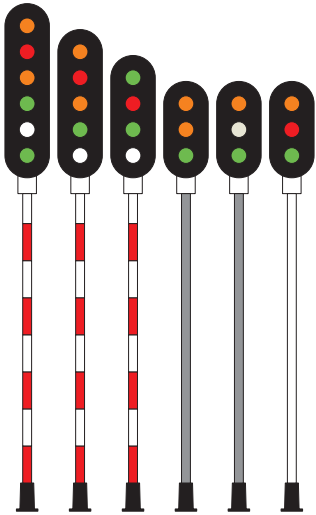

Stare układy barw komór dopuszczone warunkowo na PKP



Układy barw latarni pasa świetlnego

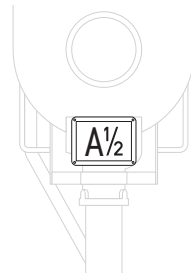

Umieszczenie pojedynczej tabliczki

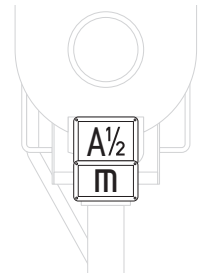

Umieszczenie dodatkowej tabliczki dla sygnału manewrowego

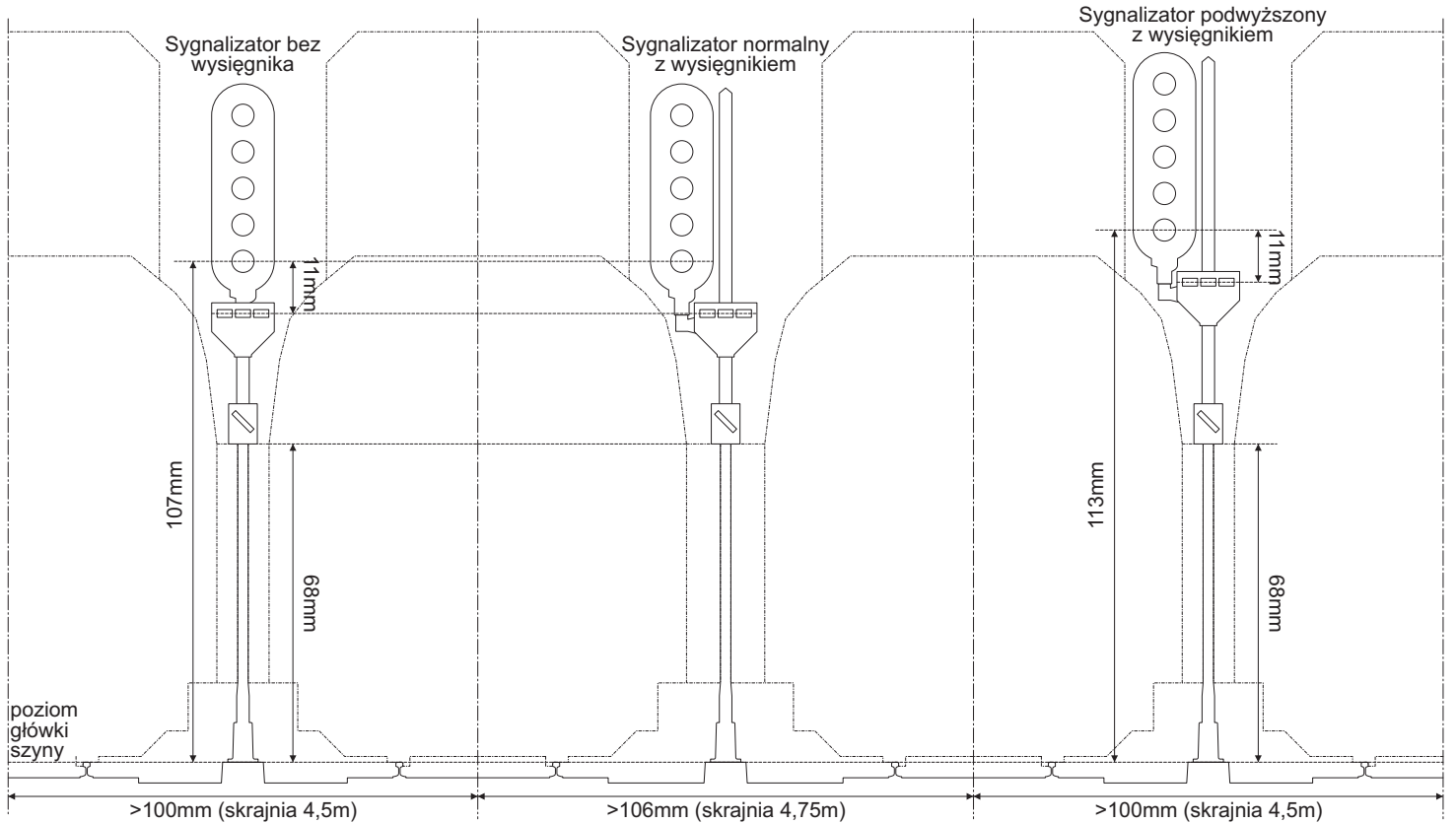

Ustawienie sygnalizatora względem skrajni

Sygnalizator świetlny PKP, skala 1:45 (0)